

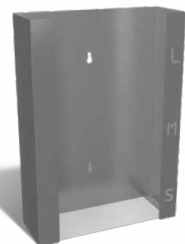

rollgroup®



PRODUKTE UND ZUBEHÖR FÜR DEN REHA-BEREICH





RAD IPP

- Radkörper aus Kunststoff (PP)
- Lauffläche aus Vollgummi
- Farbe grau, spurlos
- Präzisionskugellager



RAD

BESTELLCODE	mm	kg	mm	mm	mm
IPP 125x25-8-36	125	35	25	8	36



RAD

BESTELLCODE	mm	kg	mm	mm	mm
IPP 125x32-8-36	125	35	32	8	36



RAD

BESTELLCODE	mm	kg	mm	mm	mm
IPP 140x40-8-46	140	40	40	8	46



RAD

BESTELLCODE	mm	kg	mm	mm	mm
IPP 150x25-8-36	150	40	25	8	36
IPP 150x30-8-36	150	50	30	8	36



RAD

BESTELLCODE	mm	kg	mm	mm	mm
IPP 178x30-8-60	178	40	30	8	60





**RAD AUP**

- Radkörper aus Kunststoff (PA)
- Lauffläche aus Polyurethan (gespritzt)
- Farbe transparent
- Präzisionskugellager





RAD NPP

- Radkörper aus Kunststoff (PP)
- Lauffläche aus Polyurethan (geschäumt)
- Farbe grau, spurlos
- Präzisionskugellager





**SKATERRAD**

BESTELLCODE	 mm	 kg	 mm	 mm	 mm
AUP 050x21-8-21	50	30	21	8	21
AUP 064x24-8-24	64	30	24	8	24
AUP 076x24-8-24	76	45	24	8	24
AUP 100x24-8-24	100	50	24	8	24
AUP 125x24-8-24	125	70	24	8	24





**RAD**

BESTELLCODE	 mm	 kg	 mm	 mm	 mm
NPP 125x30-8-36	125	35	30	8	36
NPP 150x32-8-36	150	40	32	8	36





**RAD**

BESTELLCODE	 mm	 kg	 mm	 mm	 mm
NPP 150x30-8-36	150	35	30	8	36

**RAD KUNSTSTOFF-FELGE, 2-TEILIG**

BESTELLCODE	 mm	 kg	 mm	 mm	 mm
NPP 175x40-8-60 2-teilig	175	40	40	8	60
NPP 200x50-8-60 2-teilig	200	50	50	8	60

**RAD**

BESTELLCODE	 mm	 kg	 mm	 mm	 mm
NPP 175x40-8-46	175	40	40	8	46
NPP 175x40-8-60	175	40	40	8	60
NPP 200x50-8-60	200	50	50	8	60
NPP 250x50-12-54	250	50	50	12	54
NPP 300x45-12-54	300	50	45	12	54







RAD PUP

- Radkörper aus Kunststoff (PA)
- Luftbereifung
- Farbe grau, spurlos
- Präzisionskugellager







RAD

BESTELLCODE	 mm	 kg	 mm	 mm	 mm
PUP 150x30-8-36	150	40	30	8	36







RAD

BESTELLCODE	 mm	 kg	 mm	 mm	 mm
PUP 180x45-8-60	180	50	45	8	60
PUP 200x50-8-60	200	60	50	8	60



RAD KUNSTSTOFF-FELGE, 2-TEILIG

BESTELLCODE	 mm	 kg	 mm	 mm	 mm
PUP 180x45-8-60 2-teilig	180	50	45	8	60
PUP 200x50-8-60 2-teilig	200	60	50	8	60

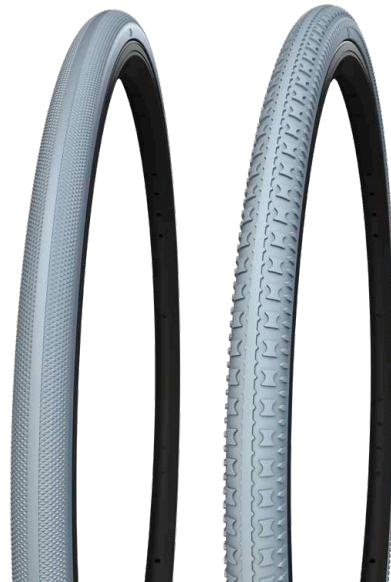

PU-REIFEN PANNENSICHER

BESTELLCODE	 Profil	Farbe	ETRTO
PU-Reifen 22x1	Rille	grau	25-489
PU-Reifen 22x1 3/8	Rille	grau	37-489
PU-Reifen 22x1 3/8	Block	grau	37-489
PU-Reifen 24x1	Rille	grau	25-540
PU-Reifen 24x1	Block	grau	25-540
PU-Reifen 24x1 3/8	Rille	grau	37-540
PU-Reifen 24x1 3/8	Block	grau	37-540

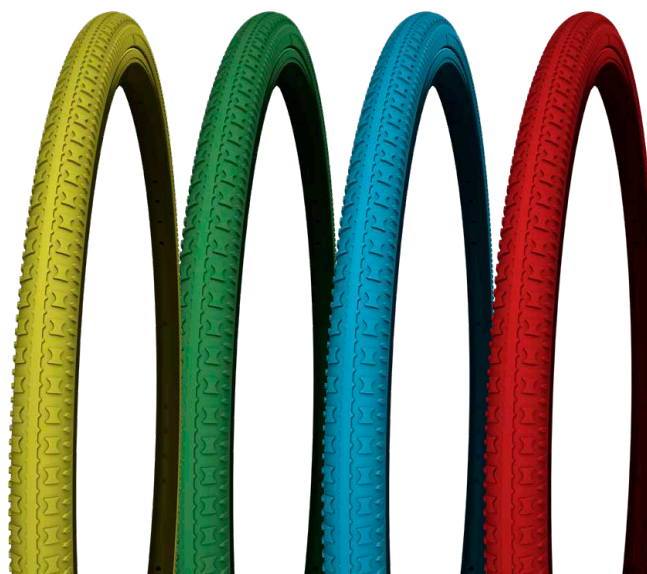



REIFEN FÜR LUFTBEREIFUNG

BESTELLCODE	Profil	Farbe	ETRTO
Decke 6x1 1/4 IS300	Rille	grau	32-86
Decke 7x1 3/4 IS300	Rille	grau	47-93
Decke 8x1 1/4 IS300	Rille	grau	32-137
Decke 8x2 IS300	Rille	grau	--
Decke 10x2 IS302	Rille	grau	54-152
Decke 12 1/2 x 2 1/4 R105	Block	grau	62-203
Decke 12 1/2 x 2 1/4 R105	Block	schwarz	62-203
Decke 12 1/2 x 2 1/4 verstärkt IS321	Block	grau	62-203
Decke 12 1/2 x 2 1/4 verstärkt R107	Block	schwarz	62-203
Decke 22x1 3/8 R119	Block	grau	37-489
Decke 24x1 R118	Rille	grau	25-540
Decke 24x1 3/8 R105	Block	grau	37-540
Decke 24x1 3/8 R121	Block	grau	37-540
Decke 26x1 3/8 R119	Block	grau	37-590

REIFEN FÜR LUFTBEREIFUNG

BESTELLCODE	Profil	Farbe
Decke 3.00-4/260x85 4PR R101	Block	grau
Decke 3.00-4/260x85 4PR R101	Block	schwarz
Decke 2.80/ 2.50-4 R108	Block	grau
Decke 2.80/ 2.50-4 R108	Block	schwarz
Decke 3.00-8 R101	Block	grau
Decke 3.00-8 R101	Block	schwarz
Decke 3.00-10 R114	Block	grau
Decke 3.00-10 R114	Block	schwarz



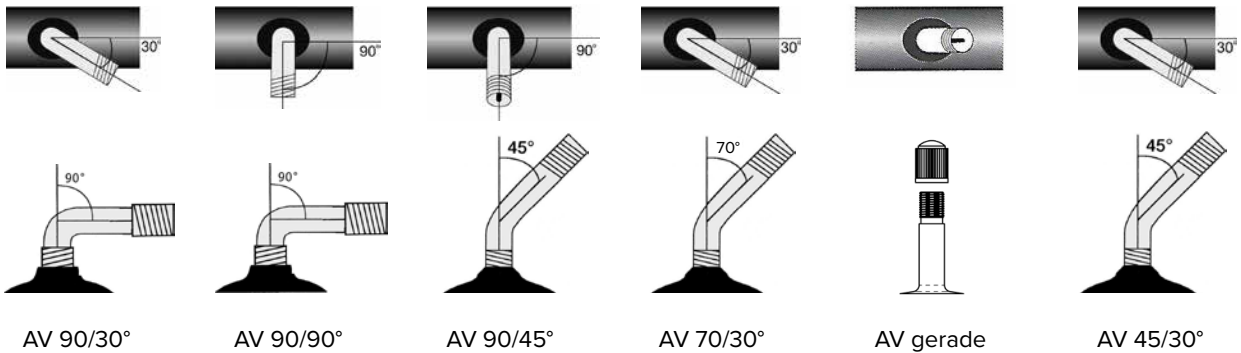

SCHLAUCH

BESTELLCODE	ETRTO
Schlauch 6x1 1/4 AV 70/30°	32-86
Schlauch 7x1 3/4 + 8x2 AV90/30°	47-93
Schlauch 7x1 3/4 + 8x2 AV90/90°	47-93
Schlauch 8x1 1/4 AV 90/45°	32-137
Schlauch 8x1 1/4 AV 30/45°	32-137
Schlauch 10x2 AV 45/30°	54-152
Schlauch 12 1/2 x 2 1/4 AV gerade	62-203
Schlauch 12 1/2 x 2 1/4 AV 90/90°	62-203
Schlauch 22x1 3/8 AV gerade	37-489
Schlauch 24x1 AV gerade	25-540
Schlauch 24x1 3/8 AV gerade	37-540
Schlauch 24x1.75 AV gerade	47-507

SCHLAUCH

BESTELLCODE	ETRTO
Schlauch 10x2 AV 90/90°	54-152
Schlauch 2.40/3.00/4.10-4 AV 90/90°	---
Schlauch 260x85/3.00-4 AV 90/90°/TR87	---
Schlauch 3.00-8 AV90/90°	---
Schlauch 3.00-10 AV gerade	---



KUNSTSTOFF-LENKGABEL MIT RÜCKENLOCH

BESTELLCODE	Gabelweite	Ausladung	Rückenloch
05L /150 P01	42,5	48,5	12,5

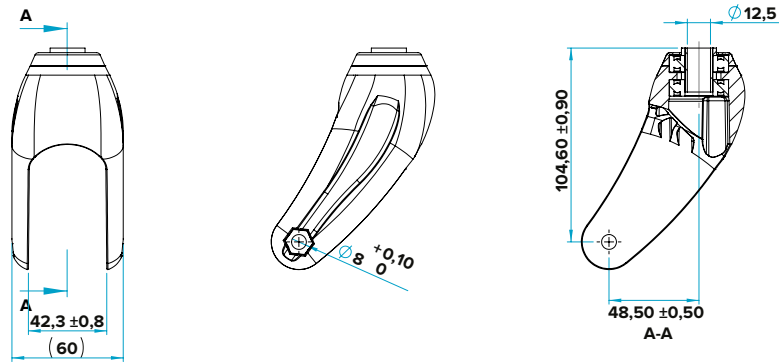

KUNSTSTOFF-LENKGABEL MIT RÜCKENLOCH

BESTELLCODE	Gabelweite	Ausladung	Rückenloch
05L /200 P01	60	47	12,5

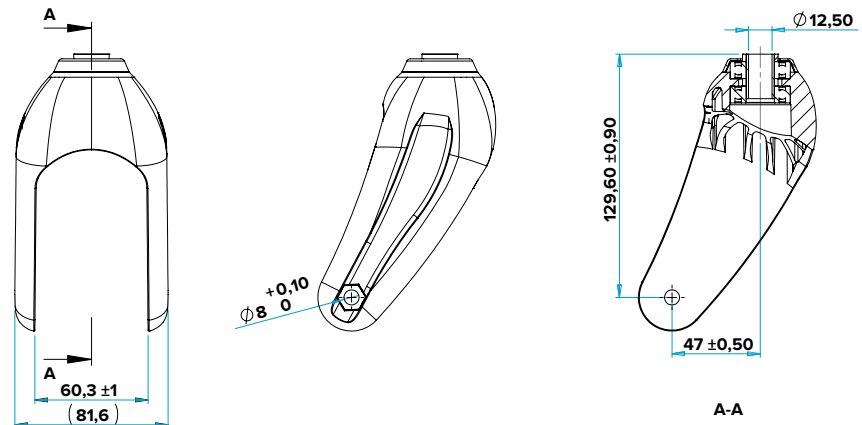

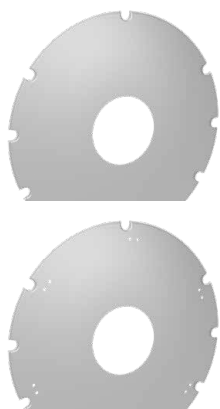

SPEICHENSCHUTZ

BESTELLCODE	Farbe
Speichenschutz 24-4/6	transparent*
Speichenschutz 24x1,5-8 mit Befestigungslochung	transparent*
Befestigungsclip	schwarz

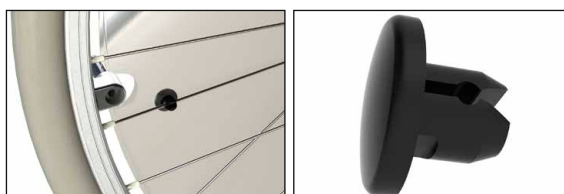

* Auf Anfrage auch bedruckte Version möglich, z.B. mit Logo.



EINKAUFNETZ BLICKDICHT

BESTELLCODE	Farbe	Volumen (l)	Traglast (kg)
RG034 NETZ	schwarz	11	20

HANDGRIFFE



BESTELLCODE	Farbe	Länge (mm)	 mm
RG008 110-22 Set	schwarz	110	22
RG009 120-22 ERGO Set	schwarz	120	22
RG033 120-25 ERGO Set	schwarz	120	25

SITZPOLSTER MIT WECHSELBAREM STOFFBEZUG



BESTELLCODE	Farbe	Breite (mm)	Tiefe (mm)	Höhe (mm)
RG031 SK480	schwarz	480	430	50
RG032 SK500	schwarz	500	430	50

Weitere Ausführungen auf Anfrage.



FESTSTELLBREMSE

BESTELLCODE

RG001 ALU links

RG002 ALU rechts

RG003 ALU-22 links

RG004 ALU-22 rechts

ARMAUFLAGE

BESTELLCODE

RG005 266-6 schwarz

L

E

266

84/140/172

RG006 360-6 schwarz

360

200/240/268

RG007 PU-370 schwarz

370

173/ 227/ 255

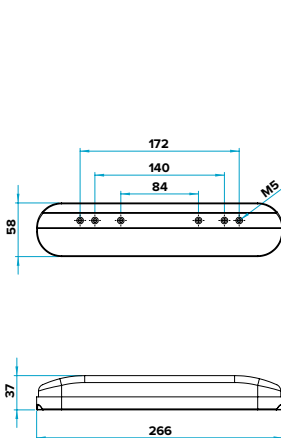

RG005

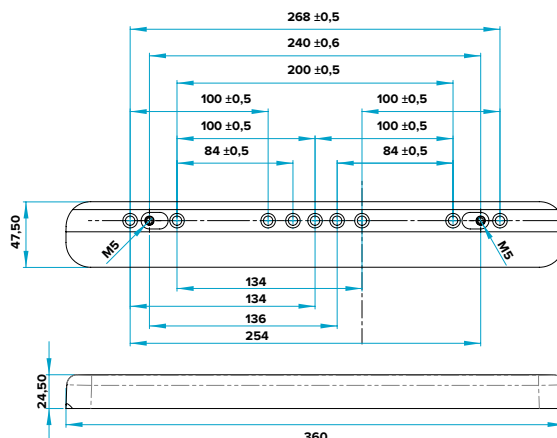

RG006

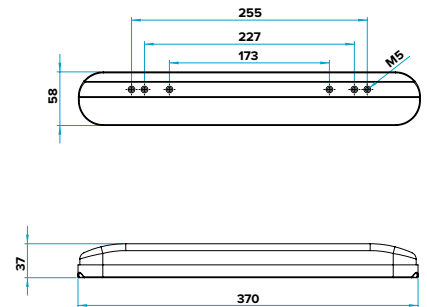

RG007

TOILETTENSITZ



BESTELLCODE	Farbe	Breite (mm)	Tiefe (mm)
RG010 TSMAE	weiß	450	435

RG011 TSOE	weiß	450	425
-------------------	------	------------	------------

RG012 TSME-176	weiß	455	450
-----------------------	------	------------	------------

RG013 TSME-178	weiß	440	350
-----------------------	------	------------	------------

ME = Mit Eimerhalterung
 OE = Ohne Eimerhalterung
 AE = Abnehmbare Eimerhalterung

TOILETTENSITZABDECKUNG



BESTELLCODE	Farbe	Breite (mm)	Tiefe (mm)
RG014 TSAD	schwarz	404	435

TOILETTENEIMER



BESTELLCODE	Farbe	Ø (mm)	Höhe (mm)
RG015 TE1-MD	grau	316	170

RG016 TE2-MD	grau	318	180
---------------------	------	------------	------------



AUFRICHTGRIFFE

BESTELLCODE

RG017 AG-700

Farbe	Höhe (mm)
grau	260 - 420

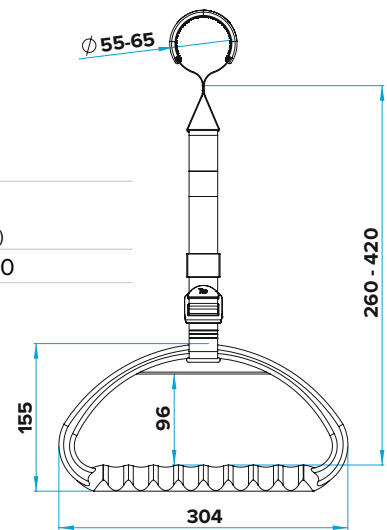

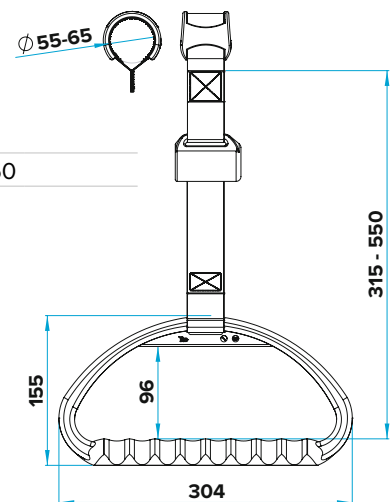

RG018 AG-GR-650

grau	315 - 550
------	-----------





ABWEISRAD

BESTELLCODE	Farbe	 mm	 mm	 mm
BPO 060-10,5-24 RAL7038	grau	60	10,5	24
BPO 060-10,6-24 RAL7038	grau	60	10,6	24
BPO 075-15,5-20 RAL7038	grau	75	15,5	20
BPO 075-15,5-20 RAL9005	schwarz	75	15,5	20
BPO 100-12,5-24 RAL7038	grau	100	12,5	24
BPO 100-33-20 RAL7038	grau	100	33	20
BPO 100-33-20 RAL9005	schwarz	100	33	20
BPO 125-12,5-12 RAL7038	grau	125	12,5	12
BPO 150-32-24 RAL7038	grau	150	32	24

ABWEISRAD ALLSEITENROLLE

BESTELLCODE	Farbe	 mm	 mm	 mm
BPO 100-10,5-40 RAL7038	grau	100	10,5	40
BPO 100-12,5-40 RAL7038	grau	100	12,5	40

Auf Anfrage alle Artikel auch in anderen Ausführungen (Außen-/ Innendurchmesser sowie Farben) möglich.



REDUZIERBUCHSE

BESTELLCODE	Ø aussen (mm)	Ø innen (mm)
RG019 12,5-8,4	12,5	8,4
RG020 12,5-10,6	12,5	10,6
RG021 33,0-22,4	33,0	22,4
RG022 33,0-25,4	33,0	25,4

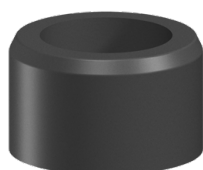



NAMENSSCHILDHALTER

BESTELLCODE

Farbe

RG024 110-32/40 rund

transparent

RG030 110-36/46 rund

transparent

RG025 100-40 vierkant

transparent



KANTENSCHUTZECKE

BESTELLCODE

RG023 Typ 1

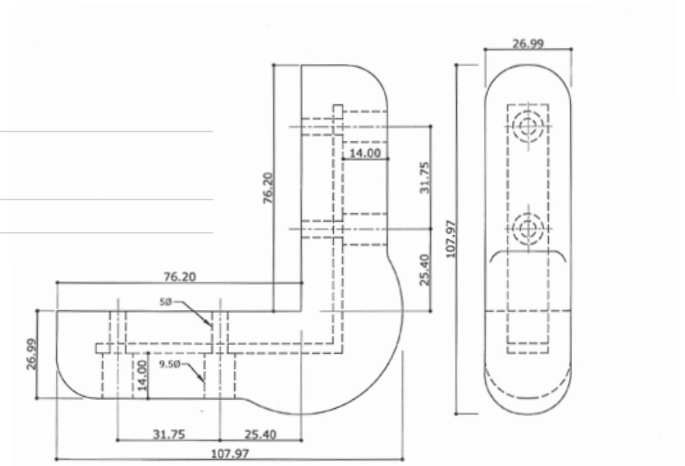

URINFLASCHENHALTER

BESTELLCODE

Farbe

RG026 UFH RAL7038

grau



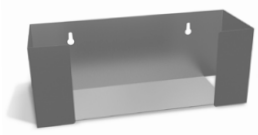

HANDSCHUHBOX PASSEND FÜR ALLE GÄNGIGEN VERPACKUNGSGRÖSSEN

BESTELLCODE	Breite (mm)*	Höhe (mm)*	Tiefe (mm)*
RG027 H-Box-1	285	126	96



RG028 H-Box-3	285	378	96
----------------------	------------	------------	-----------

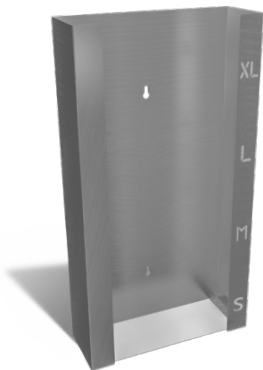

RG029 H-Box-4	285	501	96
----------------------	------------	------------	-----------

KATHETERHALTER

BESTELLCODE	Breite (mm)*	Höhe (mm)*	Tiefe (mm)*
RG035 K-Halter	178	715	76

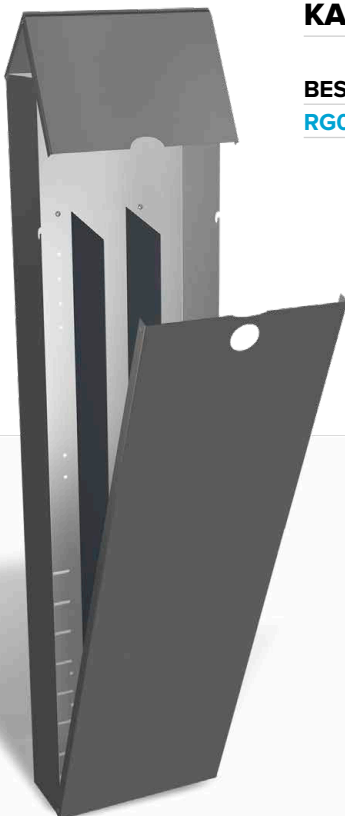

*Alle Maße sind Innenmaße!



Unser umfangreiches
Räder- und Rollenprogramm
finden Sie in unserem Hauptkatalog
oder auf unserer Website.

